

Hyper series / Prime series

3D Printer

User Manual for Hardware

Version 1.2



Contents

- Contents 2
- 1. Product Information..... 3
 - 1.1 Instructions for Use..... 3
 - 1.2 Regulatory Statements..... 3
 - 1.3 Safety Precautions..... 4
 - 1.4 General Information..... 5
 - 1.5 Package Contents 5
 - 1.6 Product Overview..... 6
- 2. Setting up your 3D printer - Hardware 7
 - 2.1 Location..... 7
 - 2.2 Unpack 7
 - 2.3 Connecting to the Power adapter and Cable..... 8
 - 2.4 Power Button Control 9
 - 2.5 Install Picker 10
 - 2.6 Fill resin tank 10
 - 2.7 Consuming Parts and Spare Parts related to resin tank..... 11
 - 2.8 How to replace Teflon film module for **Prime Series**..... 11
- 3. Operate your 3D printer –Software 12
- 4. After Print..... 12
 - 4.1 Remove Model..... 12
 - 4.2 Clean Picker 12
 - 4.3 Clean Resin Tank..... 12
- Appendix 1. Specifications 13

1. Product Information

1.1 Instructions for Use

Please read through the following **Instructions** before you start using your printer.

(1) Ensure that the glass under tank is positioned flat at the corners point, for not damaging printer while printing.

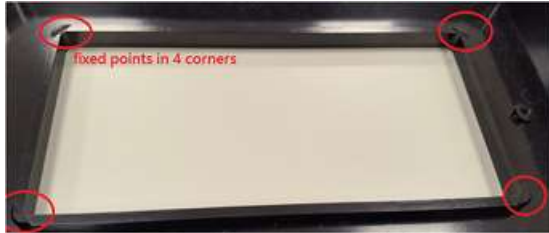

(2) Ensure no residuals inside the tank and the glass is well setup before printing.

(3) Avoid print at center point with a single object or small parts repeatedly, it may damage the tank.

1.2 Regulatory Statements

FCC NOTICE

This equipment has been tested and found to comply with the limits for a class "A" digital device, pursuant to Part 15 of the FCC Rules.

These limits are designed to provide reasonable protection against harmful interference. This equipment generates, uses, and can radiate radio frequency energy and, if not installed and used in accordance with the instruction manual, may cause harmful interference to radio communications. Operation of this equipment in a residential area is likely to cause harmful interference in which case the user will be required to correct the interference at their expense.

SAFETY CERTIFICATION

This equipment has been tested and compliance to safety requirement.

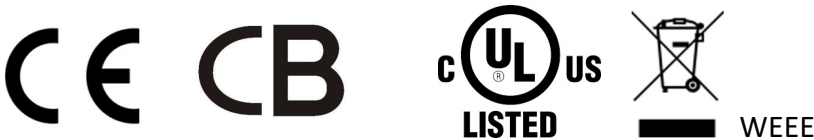

1.3 Safety Precautions

Please read through the following Safety Precautions before you start using your printer.



- (1) Use only the power adapter and accessories provided by the manufacturer.
- (2) Before plugging the power adapter into an electrical outlet, verify the local power rating conforms with the specified voltage and frequency.
- (3) This printer needs a grounded, 1-phase electrical power source.
- (4) Make sure power and communication cables are well managed to prevent from tripping.
- (5) Only use resins supplied by MiiCraft manufacturer. Use of other resins may cause printing job failure.
- (6) Do not expose the resin tank to direct light source because the resin will solidify under UV light.
- (7) Chemical substances like resin may cause skin irritation, please read the guidelines in Material Safety Data Sheet (MSDS) of the resin supplied by manufacturer. It is recommended to wear gloves when necessary.
- (8) When moving the printer for a long distance, be sure to withdraw the remaining resin in reaction tank and clean the tank in advance to prevent from resin overflow.
- (9) Keep door closed during printing or curing to prevent UV leakage.
- (10) UV light may cause injury of eyes, do not stare into the printer directly when it is in operation. It is recommended to wear UV protective glasses during operating the printer.
- (11) Place the device on a level surface and keep the printer in an upright position at all times.
- (12) Do not store the printer in extreme hot and cold temperatures.
- (13) Do not disassemble or repair the device yourself. Doing so may cause device malfunction or danger.
- (14) Warning: Picker is hazardous moving parts in MiiCraft Printer. Keep hands away from picker's motion path.
- (15) Emergency shut down method: Press Power Button and hold 3 seconds to shut down.
- (16) This product is designed for specific application and needs to be installed by a qualified personal who has 3D printer and related rule knowledge. A qualified person understands the requirements and risks involved with installing electrical equipment in accordance with national codes.

1.4 General Information

Product Name	Prime 150/110 Hyper 125/80/50
Power Input	100~240V AC, 50Hz/60Hz
Adapter	Hyper : 19V DC / 4.73A 19.5V DC / 6.15A 19.5V DC / 6.7A Prime : 19.5V DC / 6.15A 19.5V DC / 6.7A
Printer Dimension W x D x H	50 x 57 x 59 cm
Package Size and Weight	80 x 80 x 93 cm / 76 kg (Including pallet)
Operating Temperature	10° to 30°
Humidity (RH)	40% to 60% Our printer should keep in dry conditions
Storage of Printing Material	Store the materials at ambient temperature from 15° to 28° And do not exposure to the light, otherwise resin may solidified

- Liability: We will not hold the responsibility for damages of the machine or injuries on the operator in case user do not follow the user guide instruction.
- Repair can only be carried out by authorized person of MiiCraft.

1.5 Package Contents

There is a printer and an accessory box inside the package. As soon as you receive our products, please verify its content and check if there's any exterior damage due to transportation.



1.6 Product Overview

Front View

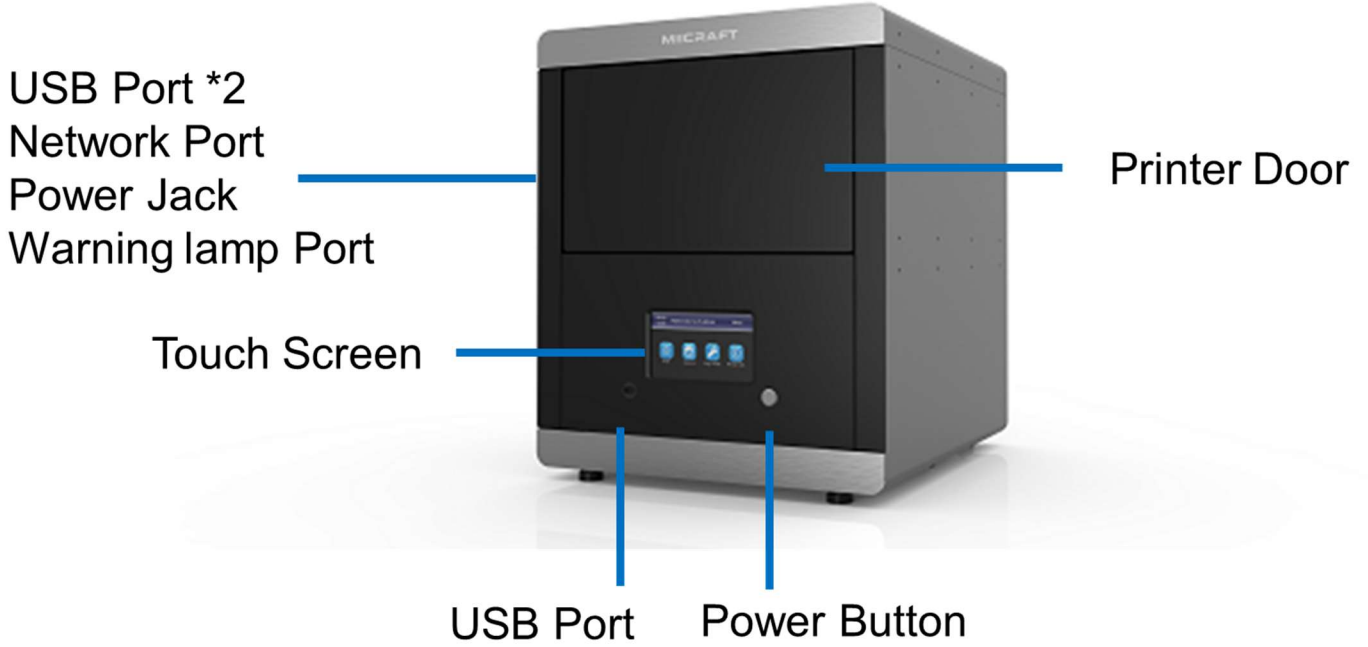

Inside View

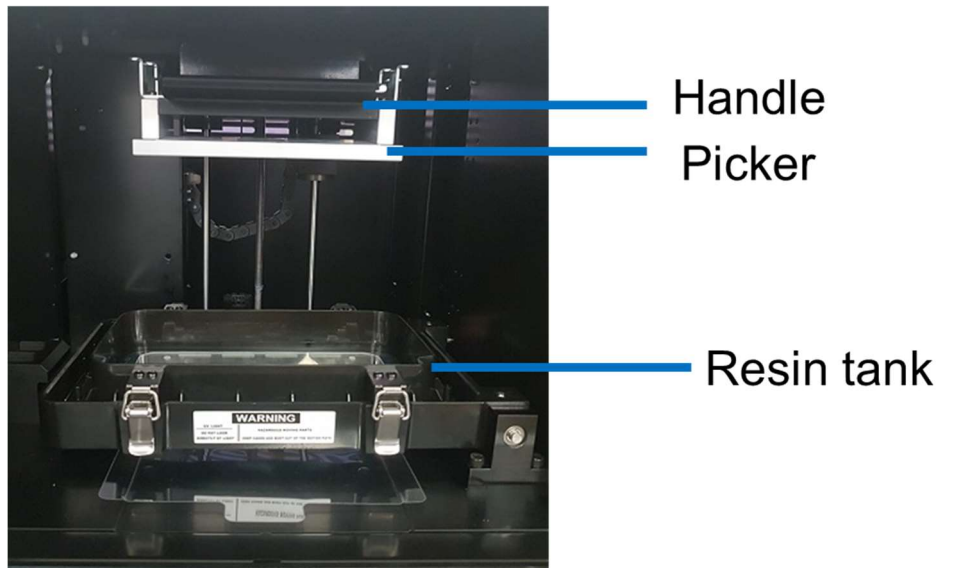

2. Setting up your 3D printer - Hardware

2.1 Location

Ensure your Ultra printer is placed on a flat table top with access to mains electricity. Avoid sunlight direct as this will degrade material left in the machine.

WARNING Dust pollution will cause printing failure. Do not place your printer in dusty environment, such as zirconia milling workplace.

2.2 Unpack

(1) Remove the top cardboard

(2) Remove the EPE surround the inner box

(3) Remove the side cardboard

(4) Remove the inner box



WARNING Printer net weighs at least 56 kilograms. Please be careful, and use proper lifting techniques to avoid injury.

NOTE Do not discard your carton. Put it in a safe place should you need to ship your printer for any reason.

2.3 Connecting to the Power adapter and Cable

(1) Connect the power cord and adapter to your device, and then plug it into an electrical outlet

(2) Connect your printer with laptop

- Basic : Connect printer and laptop by RJ-45 cable (Graph1.) [Initiating time 1 minute]
- LAN : Connect both printer and laptop to local area network [Initiating time a few seconds]
- IP sharer : Connect both printer and laptop to IP sharer [Initiating time a few seconds]

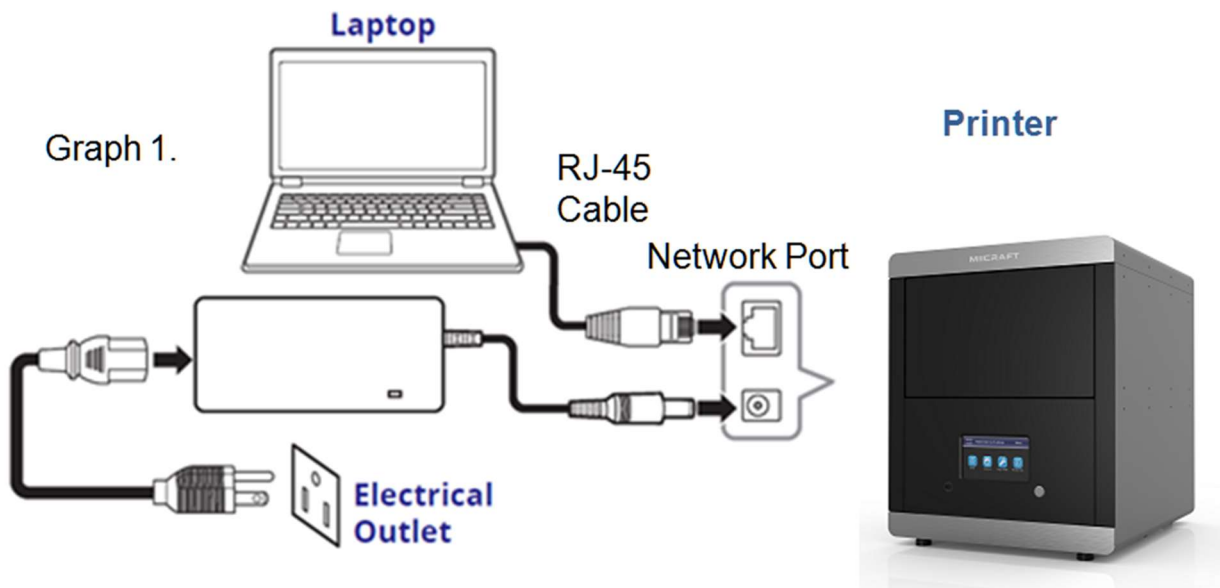

2.4 Power Button Control

(1) Power On

Press Power Button => Panel shows Starting up => Panel shows Menu



(2) Power Off

Press Power Button => Confirm message => Confirm to shut down

(3) Emergency shut down

Press Power Button and hold 3 seconds to shut down

(4) Power Button Signal

Blue		Solid	Standby mode
		Blinking	Starting up or printing in progress
Red		Solid	Error

2.5 Install Picker

Carry both end of picker and install it onto the machine



Put down the handle to lock the Picker

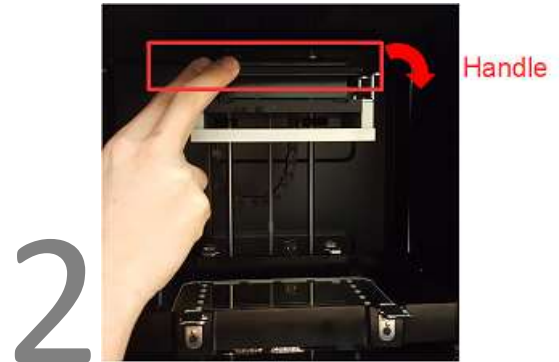

※ Remove the Picker: Lift the handle→Carry both end of picker→Remove the Picker

2.6 Fill resin tank

Unlock the Resin tank from four corners

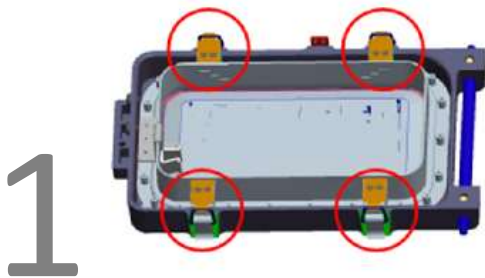

Pick up the resin tank



Pour resin



※ While install the tank, the side with sheet metal should toward printer (see as below picture)

※ Remember to lock four corners of resin tank after install it.

※ EPE has to be removed before First printing



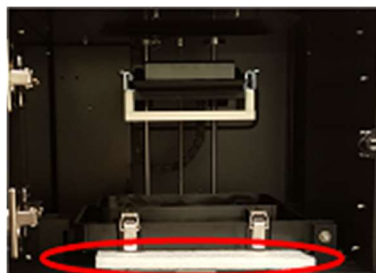

This side with sheet metal





2.7 Consuming Parts and Spare Parts related to resin tank

Consuming Parts

Hyper Series	Prime Series
<p data-bbox="331 439 579 477">Teflon Module</p> 	<p data-bbox="986 439 1318 477">Teflon Film Module</p> 

Spare Parts

Prime Series	
<p data-bbox="323 1160 576 1245">Teflon Module Top View</p> 	<p data-bbox="1023 1160 1276 1245">Teflon Module Back View</p> 

2.8 How to replace Teflon film module for **Prime Series**

- (1) Turn back teflon module
- (2) Dismantle 16 units screws (As teflon module back view picture, red area)
- (3) Take out old Teflon film module, and put new Teflon film module
- (4) Mount 16 screws, but do not tighten them at once (just mount them in position temporarily)
- (5) Then fasten 16 screws

3. Operate your 3D printer –Software

Please refer to Utility User Manual, all-in-one software for MiiCraft printers.

4. After Print

4.1 Remove Model

Lift the handle → Remove the Picker and printed model → Use air gun and ethanol to clean the printed model → Post curing (Additional post curing unit is required) → Carefully remove the printed model from the picker. → Use putty knife to help separate the printed model and picker



WARNING Do not expose the resin tank to direct light source because the resin will solidify under UV light. Use tray to cover the resin tank to prevent solidify.

4.2 Clean Picker

Use putty knife or similar object to scrape away the excess printed model on the picker. If any greasy residue persists, use a soft cloth dipped in alcohol to rub the surface until the grease is removed.

WARNING Do not use chisel to scrape off the printed parts on the picker. The rugged surface of picker will cause the resin tank & UV glass be damaged.

4.3 Clean Resin Tank

Pour resin out of tank → Pour ethanol into tank and soak in a while → Use tissue or lens tissue softly wipe the bottom of tank → Finished cleaning. Or let the projector help cleaning Tank, please refer to Utility user manual, the cleaning Tank Process.



Notifications:

- Do not shut down the power during curing
- Do not interrupt the firmware upgrade process. Any interruptions during the firmware upgrade process may cause your printer to malfunction
- Update the firmware frequently for better user experience
- Before printing, please check the surface of picker and tank is clean, no residual, otherwise it may affect printing quality
- Hyper series Tank module and Prime series Teflon film module are consumables, we suggest to replace for them while using for a period, otherwise it may affect printing quality

Appendix 1. Specifications

Specification

Item	Prime 150	Prime 110	Hyper 125	Hyper 80	Hyper 50
Area(mm)	150x84.5x120	110x62x120	125x70x120	80x45x120	57x32x120
XY Res.	55 µm	40 µm	65 µm	41.5 µm	30 µm
Z-Layer Resolution	5 µm to 500 µm				
Wavelength(LED)	385/405 nm wavelength are available for all configurations				
UI & Connectivity	Touch screen / Ethernet, USB				
Software	Operating System: Windows7, Windows8, Windows10 Network Browser: Google Chrome File input: .SLC, .STL File input size limitation: (1) Upload file from Computer, file limitation 500MB (2) Upload file from USB, file limitation 1G				
Power Input	100~240V AC, 50Hz/60Hz				
Adapter	Hyper : 19V DC / 4.73A 19.5V DC / 6.15A 19.5V DC / 6.7A Prime : 19.5V DC / 6.15A 19.5V DC / 6.7A				
Operating Environment	Temperature: 10° to 30° Humidity (RH): 40% to 60%				
Printer dimension W x D x H (cm)	50 x 57 x 59 cm / 56 kilogram				
Package size and weight W x D x H (cm)	80 x 80 x 93 cm / 76 kilogram				

* All specification and design subject to change without notice